



LED Display
Product Data Sheet
LTS-5825CKG-PST1

Spec No. :DS30-2012-0060
Effective Date: 01/08/2020
Revision: B

LITE-ON DCC

RELEASE

BNS-OD-FC001/A4

LED DISPLAY**LTS-5825CKG-PST1**
DATA SHEET

<u>ITEM</u>	<u>Description</u>	<u>By</u>	<u>DATE</u>
1	New Spec	Reo Lin	2012/06/06
2	Revised P/N name from LTS-5825CKG-P-ST1 to LTS-5825CKG-PST1	Reo Lin	2012/06/19
3	Update Packing spec. in page 9	Reo Lin	2019/1125
4	Add Direction of pulling out of packing spec	Anon B	2019/1218

FEATURES

- * 0.56 inch (14.22 mm) DIGIT HEIGHT
- * CONTINUOUS UNIFORM SEGMENTS
- * LOW POWER REQUIREMENT
- * EXCELLENT CHARACTERS APPEARANCE
- * HIGH BRIGHTNESS & HIGH CONTRAST
- * WIDE VIEWING ANGLE
- * SOLID STATE RELIABILITY
- * CATEGORIZED FOR LUMINOUS INTENSITY

DESCRIPTION

The LTS-5825CKG-PST1 is a 0.56 inch (14.22 mm) digit height single digit SMD display. The devices utilize AlInGaP Green LED chips, which are made from AlInGaP on a non-transparent GaAs substrate. The display has black face and white segments.

DEVICE

PART NO.	DESCRIPTION
AlInGaP green	Common Anode
LTS-5825CKG-PST1	

PACKAGE DIMENSIONS

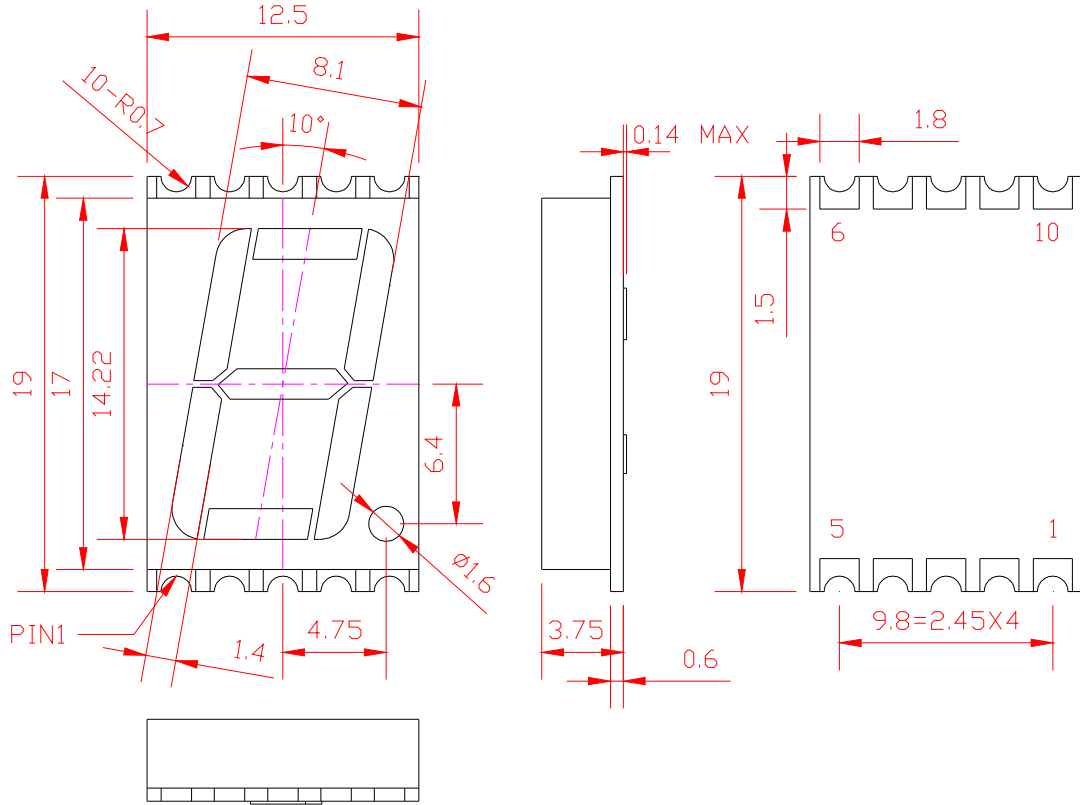

Solder Pad Vs Painting Diagram

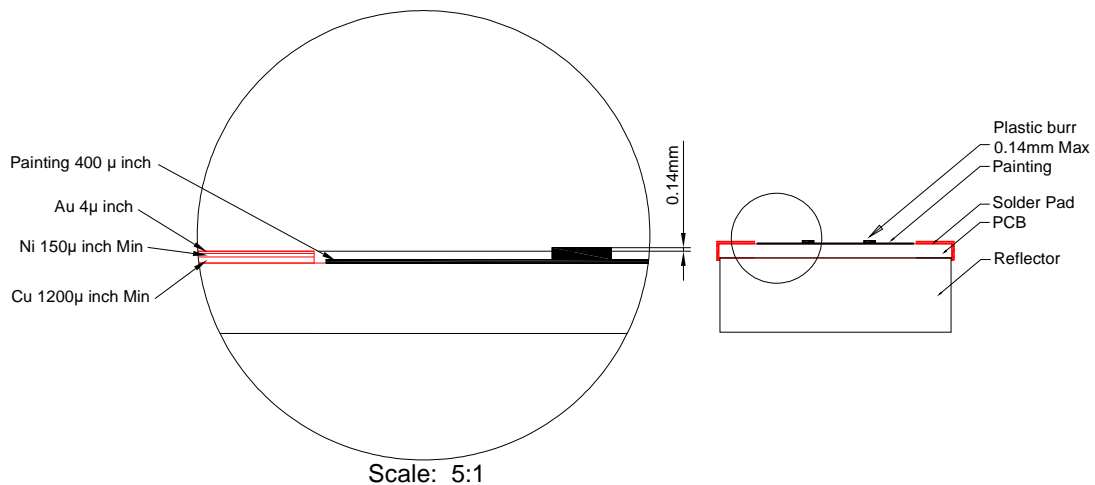

NOTES:

1. Plastic pins' burr maximum 0.14 mm, warping of PCB maximum 0.06 mm.
2. All dimensions are in millimeters. Tolerances are ± 0.25mm (0.01“) unless otherwise noted.
3. Solder pad materials and thickness: Cu: 1200 μ inch Ni: Min 150 μ inch Au: 4 μ inch.

INTERNAL CIRCUIT DIAGRAM

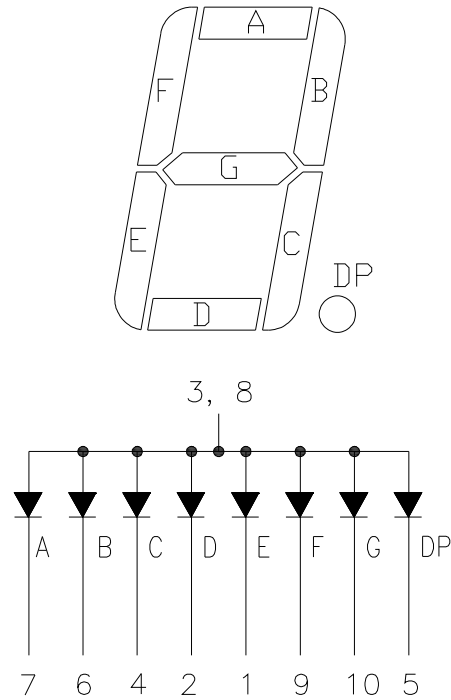

PIN CONNECTION

No.	CONNECTION
1	CATHODE E
2	CATHODE D
3	COMMON ANODE
4	CATHODE C
5	CATHODE DP
6	CATHODE B
7	CATHODE A
8	COMMON ANODE
9	CATHODE F
10	CATHODE G

ABSOLUTE MAXIMUM RATING AT Ta = 25 ° C

PARAMETER	MAXIMUM RATING	UNIT
Power Dissipation Per Segment	70	mW
Peak Forward Current Per Segment (Frequency 1Khz,10% duty cycle)	60	mA
Continuous Forward Current Per Segment	25	mA
Forward Current Derating from 25 ° C	0.28	mA/° C
Operating Temperature Range	-40 ° C to +105 ° C	
Storage Temperature Range	-40 ° C to +105 ° C	
Soldering Conditions: 1/16 inch Below Seating Plane for 3 Seconds at 260 ° C		

ELECTRICAL / OPTICAL CHARACTERISTICS AT Ta = 25 ° C

PARAMETER	SYMBOL	MIN.	TYP.	MAX.	UNIT	TEST CONDITION
Luminous Intensity	IV	501	1700		μ cd	IF=1mA
Peak Emission Wavelength	λp		571		nm	IF=20mA
Spectral Line Half-Width	Δλ		15		nm	IF=20mA
Dominant Wavelength	λd		572		nm	IF=20mA
Forward Voltage Per Segment	VF		2.05	2.6	V	IF=20mA
Reverse Current Per Segment ⁽²⁾	IR			100	uA	VR=5V
Luminous Intensity Matching Ratio	Iv-m			2:1		IF=1mA

Note:

1. Luminous intensity is measured with a light sensor and filter combination that approximates the CIE (Commision Internationale De L'Eclairage) eye-response curve.
2. Reverse voltage is only for IR test. It can not continue to operate at this situation.
3. Cross talk specification $\leq 2.5 \%$

TYPICAL ELECTRICAL / OPTICAL CHARACTERISTIC CURVES

(25°C Ambient Temperature Unless Otherwise Noted)

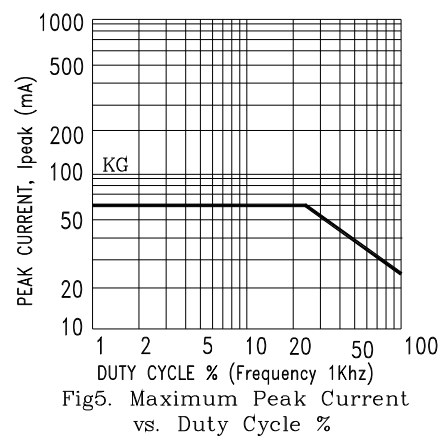
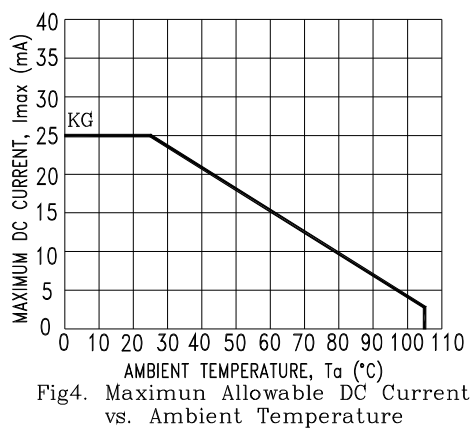
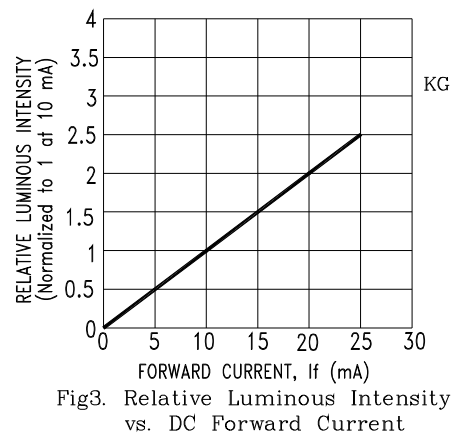
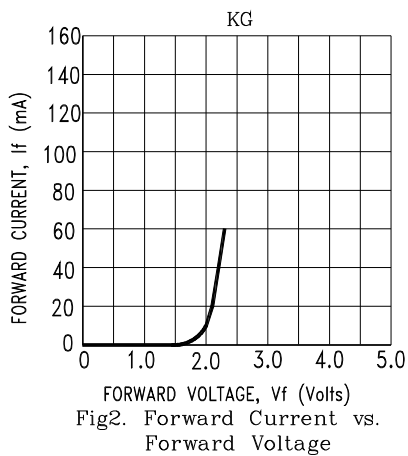
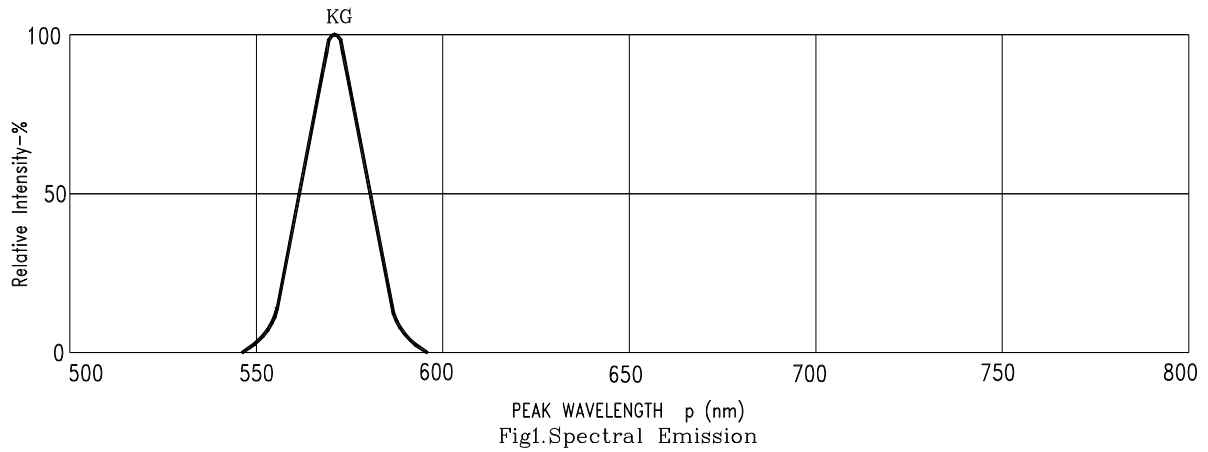

NOTE : KG=AlInGaP Green

SMT SOLDERING INSTRUCTION

(Number of reflow process shall be less than 2 times, and cooling process to normal temperature is required between the first and the second soldering process)

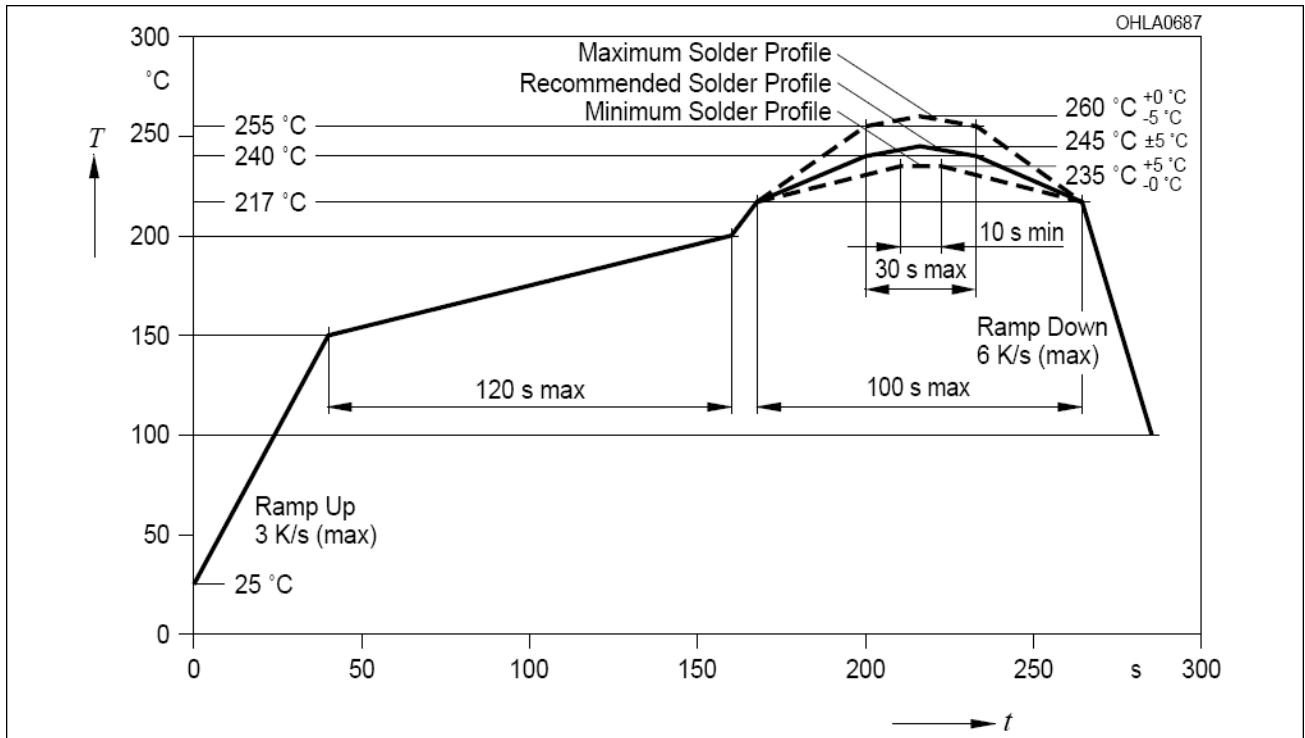

Note:

1. Recommended soldering condition:

Reflow Soldering (Two times only)		Soldering Iron (One time only)	
Pre-heat:	120~150 °C	Temperature	300°C Max.
Pre-heat time:	120sec. Max.	Soldering time	3sec. Max.
Peak temperature:	260 °C Max.		
Soldering time:	5sec. Max.		

2. Number of reflow process shall be less than 2 times, and cooling process to normal temperature is required between the first and the second soldering process.

RECOMMENDED SOLDERING PATTERN (UNIT: MM)

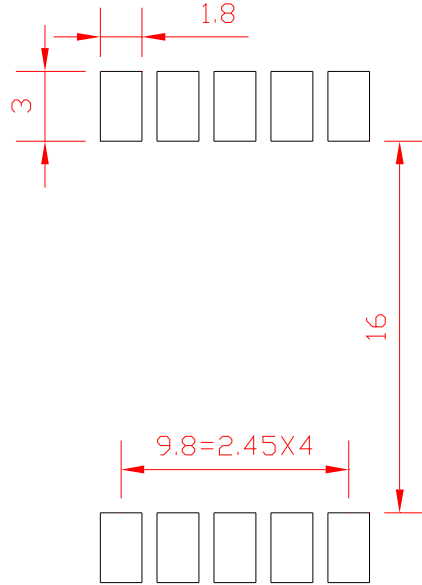

PACKING REEL DIMENSIONS

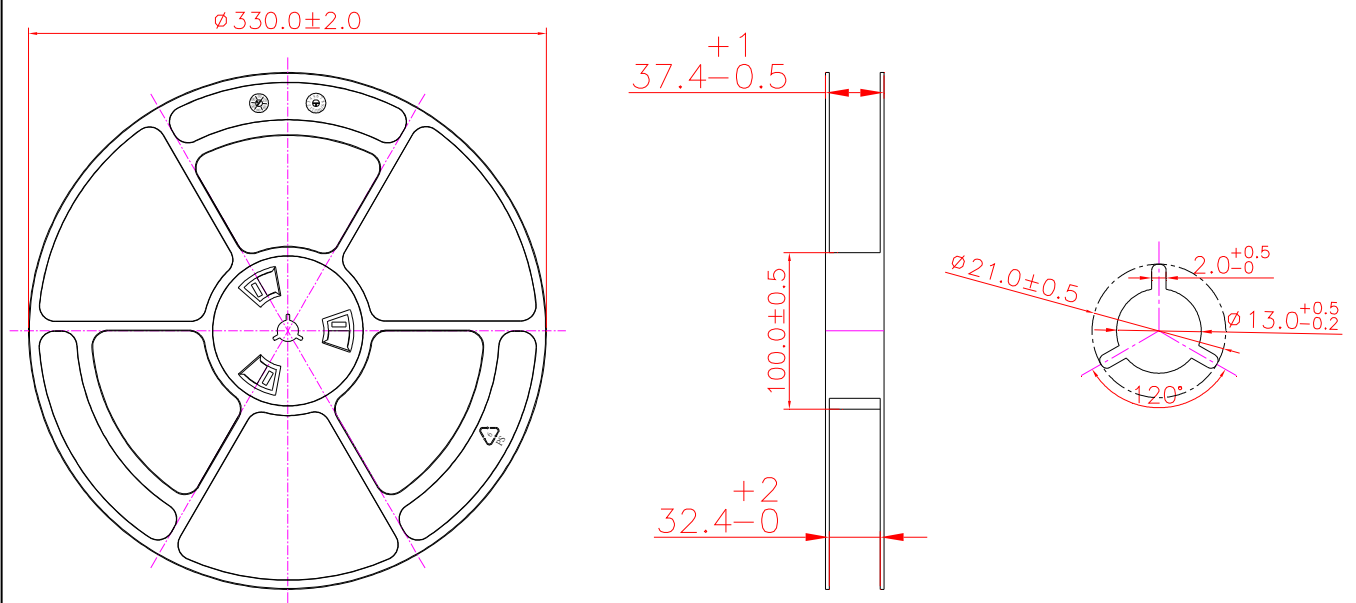

PACKING CARRIER DIMENSIONS

1. Taping parts:

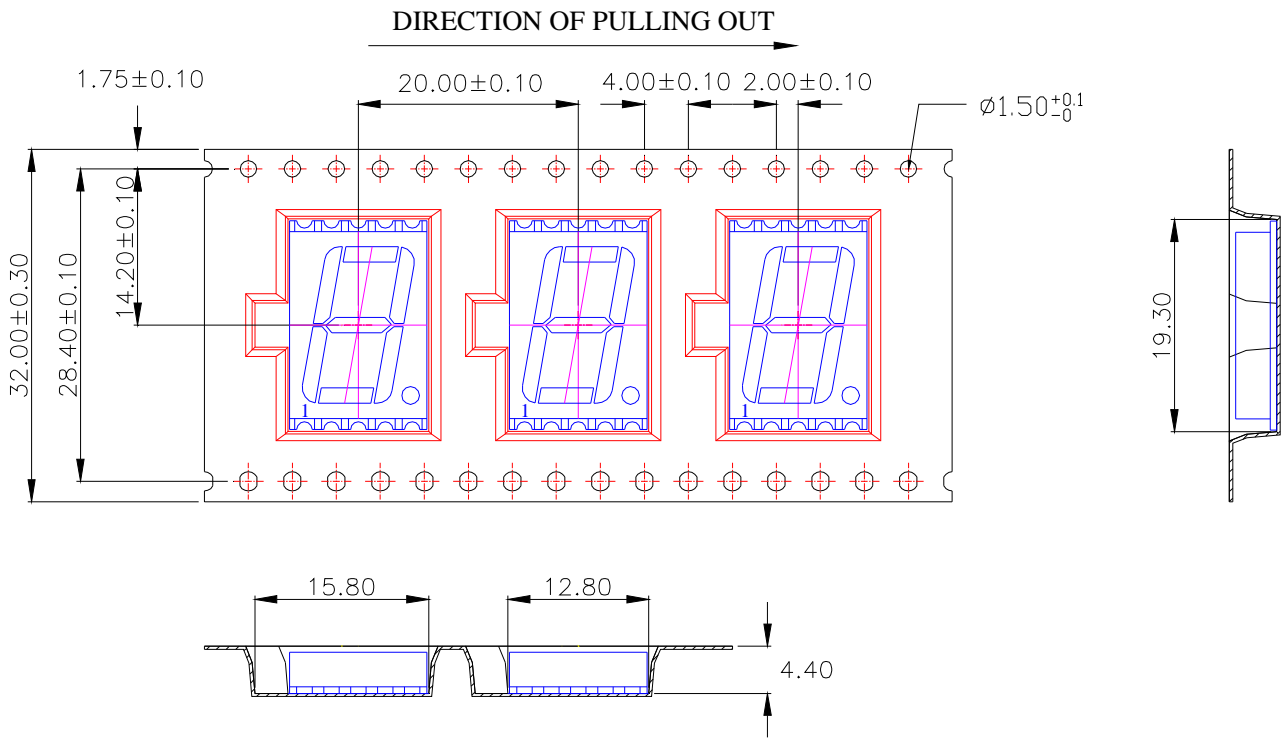

1. 10 sprocket hole pitch cumulative tolerance ± 0.20 .
2. Carrier camber is within 1 mm in 250 mm.
3. Material : Black Conductive Polystyrene Alloy.
4. All dimensions meet EIA-481-D requirements.
5. Thickness : 0.30 ± 0.05 mm.
6. Packing length per 22" reel : 44.5 Meters.(1:3)
7. Component load per 13" reel : 700 pcs.
8. Minimum packing quantity is 200 pcs for remainders

2. Trailer part/ Leader part:

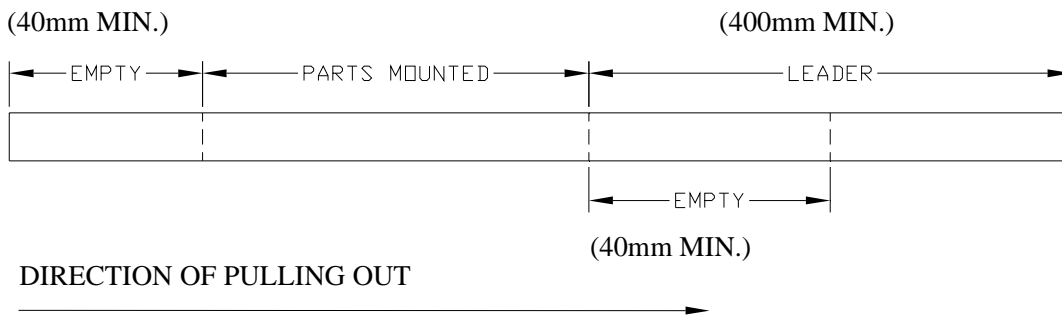

MOISTURE PROOF PACKAGING

All N/D SMD displays are shipped in moisture proof package. The displays should be stored at 30°C or less and 90% RH or less. Once the package opened, moisture absorption begins.

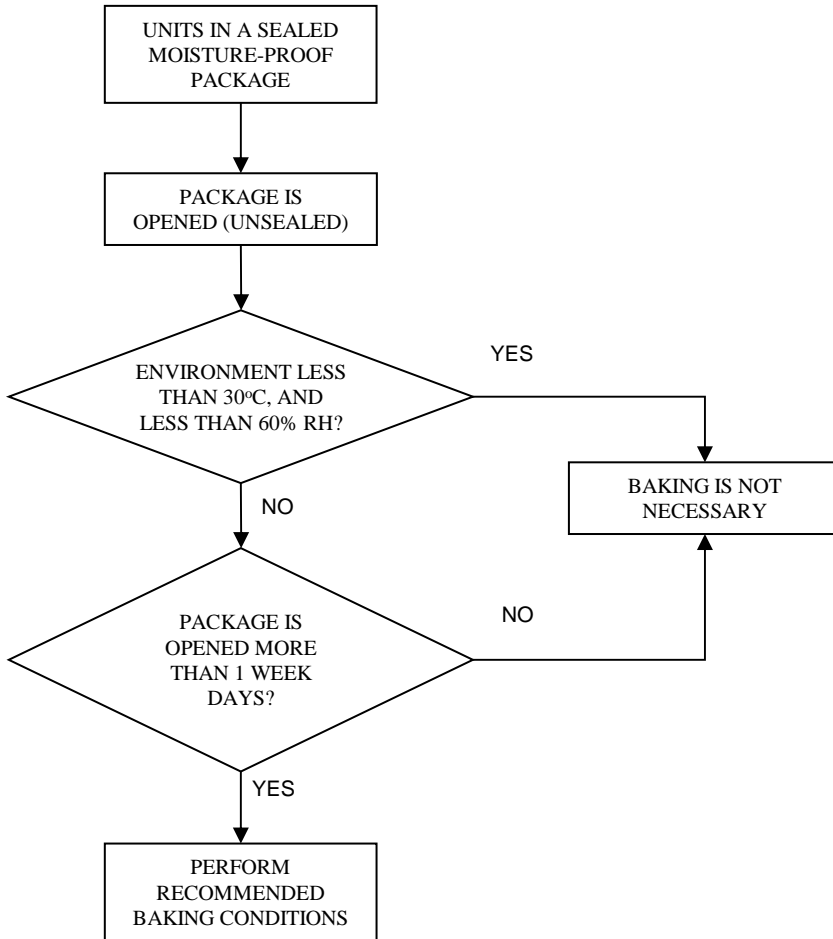

Baking Conditions

If the parts are not stored in dry conditions, they must be baked before reflow to prevent damage to the parts.

Package	Temperature	Time
In Reel	60 °C	≥ 48hours
In Bulk	100 °C	≥ 4hours
	125 °C	≥ 2hours

Baking should only be done once.